

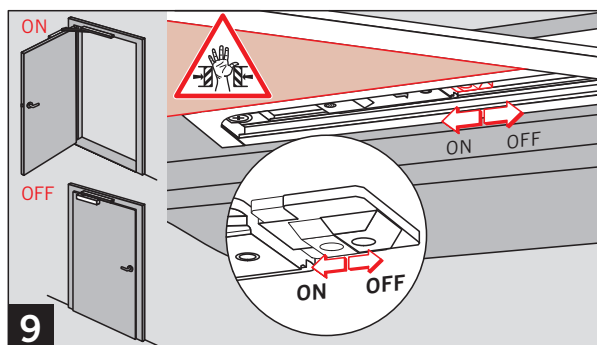

WN 056739 45532
11/11

Art. Nr.18570000

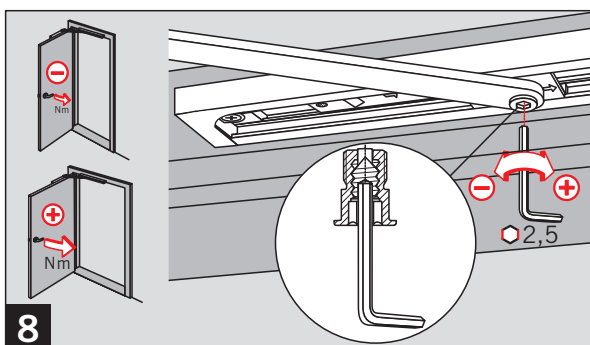

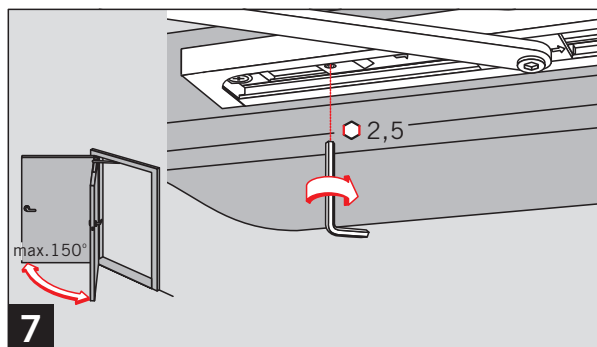
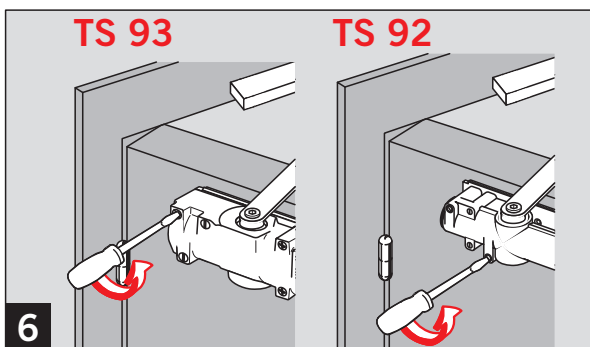
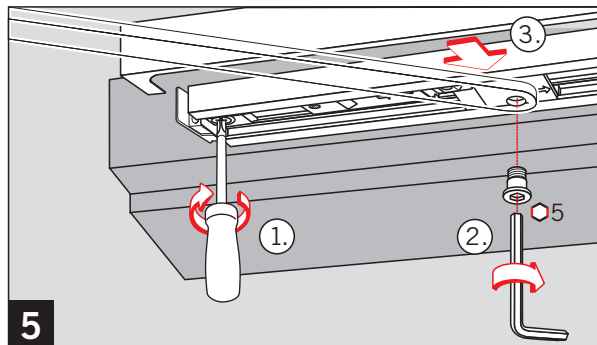
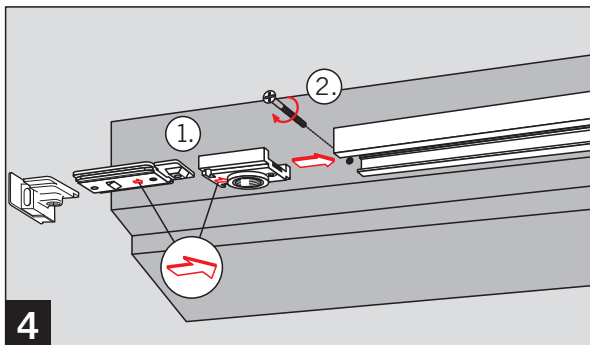
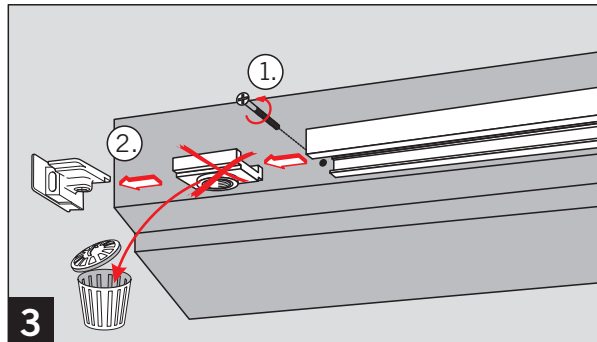
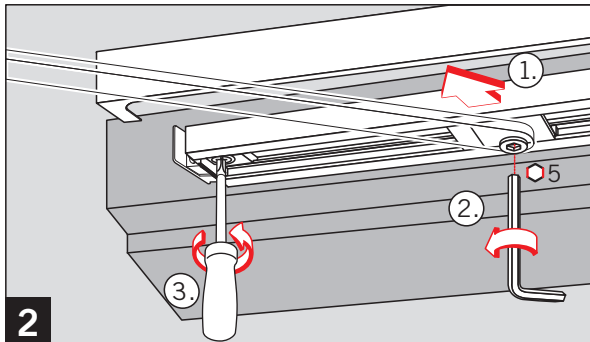
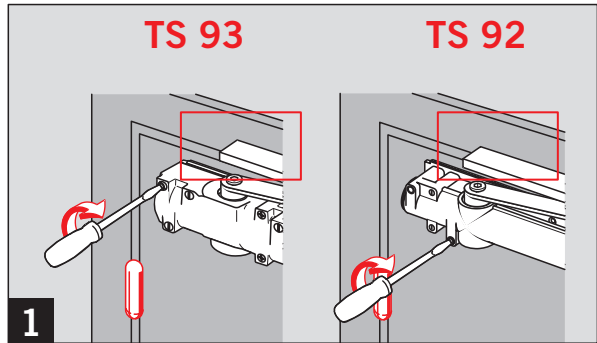
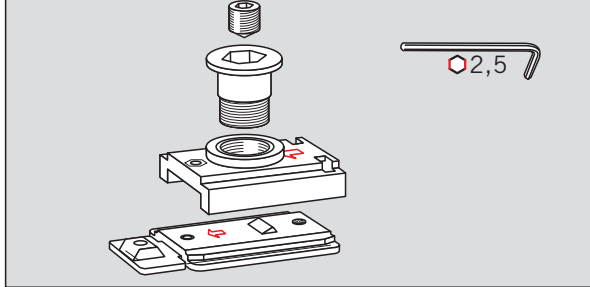

Art. Nr.18570000

