

Planungsmaße

Dispensa mit Vollauszug – 100 kg

Obere Korpuschiene

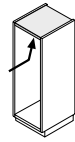
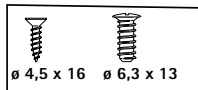
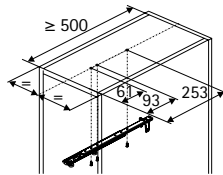

Dispensa mit Vollauszug – 100 kg mit eTouch+

Obere Korpuschiene

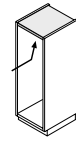
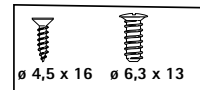
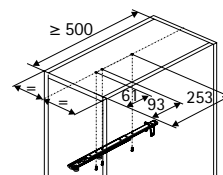

Untere Korpuschiene

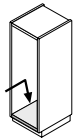
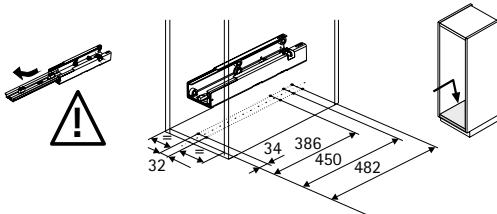

Untere Korpuschiene

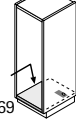
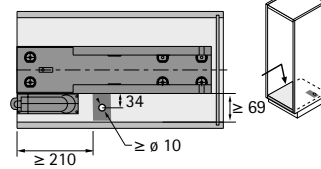

Fronthalter / -schienen

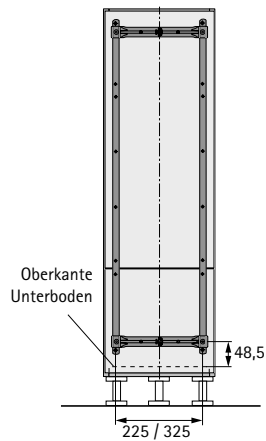

Fronthalter / -schienen

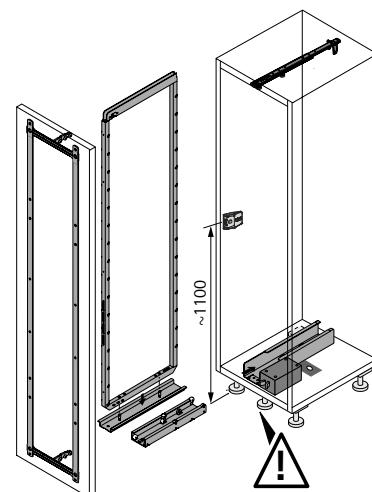
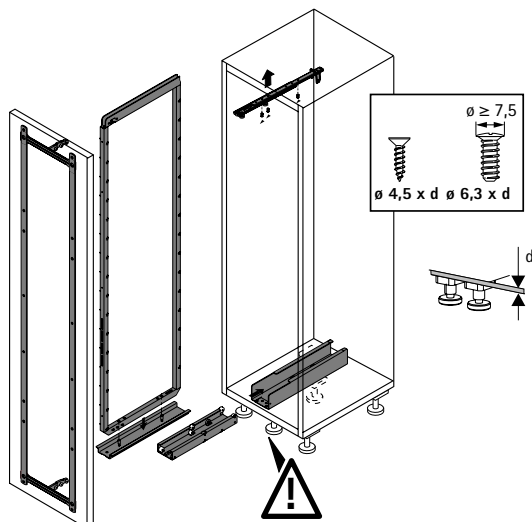
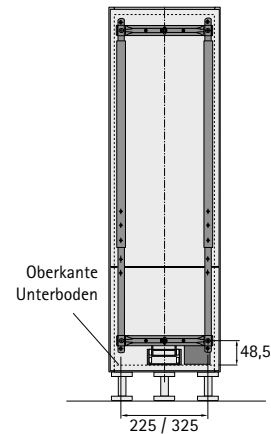

Hochschrankausstattung

- ▶ Dispensa 90°
- ▶ Zubehör

Stabilisator für Rahmenfronten



- ▶ Beim Einsatz von Rahmenfronten erforderlich
- ▶ Stahl pulverbeschichtet

Für Korpusbreite mm	Bestell-Nr. / Farbe		VE
	silber	anthrazit	
300	0 070 798	9 277 672	1 St.
400	0 070 799	9 277 673	1 St.

Stabilisator



- ▶ Für den positionsunabhängigen Einsatz
- ▶ Optional einsetzbar
- ▶ Stahl pulverbeschichtet

Farbe	Bestell-Nr.	VE
silber	0 070 800	1 St.
anthrazit	9 277 671	1 St.

Korbhalter für höhenverstellbaren Tragrahmen

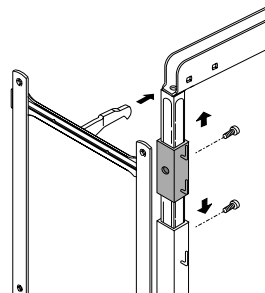

- ▶ Optimale Raumaussnutzung im Höhenverstellbereich des Tragrahmens
- ▶ Höhe 125 mm
- ▶ Stahl pulverbeschichtet

Set besteht aus:

- ▶ 2 Stück Korbhalter

Farbe	Bestell-Nr.	VE
silber	0 074 848	1 Set
anthrazit	9 277 674	1 Set